

# SISCO

P/T PLUGS

TEST  
PLUGS

FOR

PRESSURE

OR

TEMPERATURE

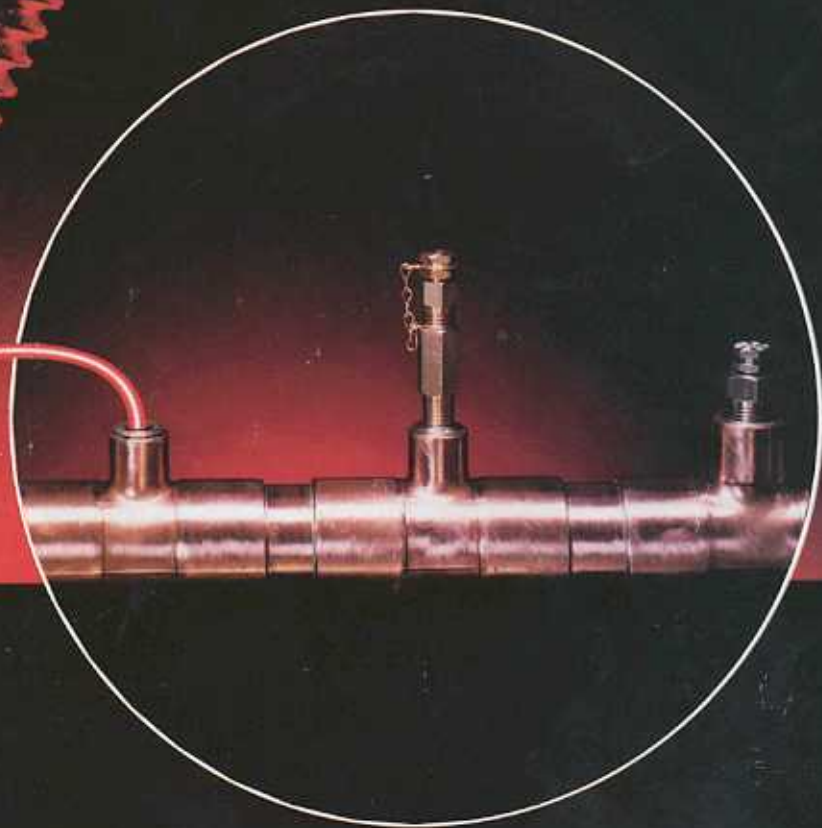
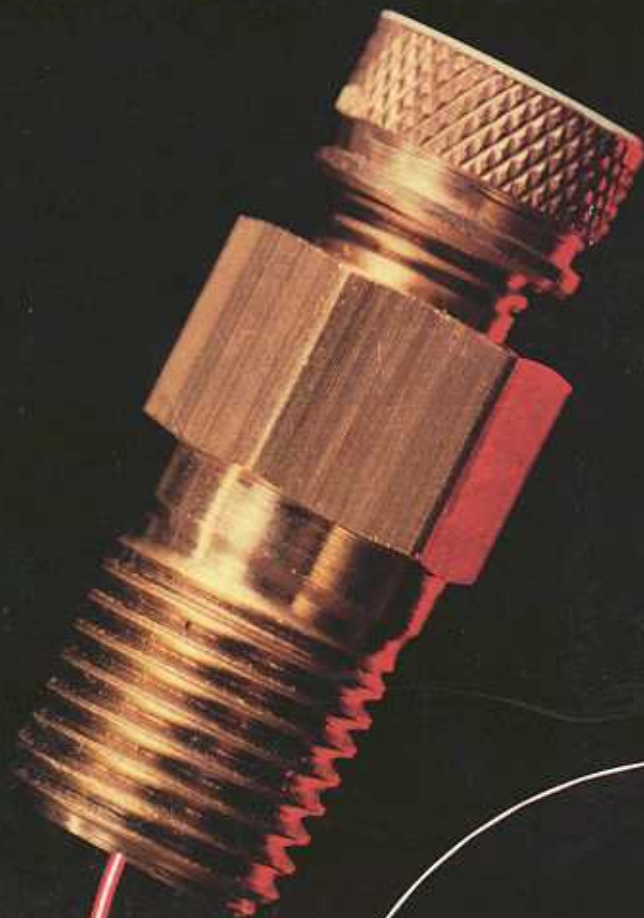

# SISCO

## DUAL SEAL CORE



## WHY A SISCO PLUG?

### ZERO LEAKAGE TO 1000 PSIG

OUR DUAL CORE SEAL DESIGN WITH THE MEMBRANE COUPLER SERVES A DUAL PURPOSE...

- DUAL CORE DESIGN ALLOWS THE BOTTOM SEAL TO CLOSE, SEALING YOUR SYSTEM BEFORE THE PROBE IS FULLY REMOVED THROUGH THE TOP CORE.
- THE MEMBRANE CONNECTING THE TWO SEPARATE CORES MAINTAINS TRUE ALIGNMENT FOR INCREASED EASE WHEN INSERTING PROBES.

## SISCO'S 1/8" MINI PLUG

THIS SISCO PLUG WAS CREATED AT THE REQUEST OF OUR CUSTOMERS FOR USE WHERE SPACE IS CONSTRAINED. USE ANYWHERE YOU CAN USE A 1/8" NPT SCHRADER VALVE.

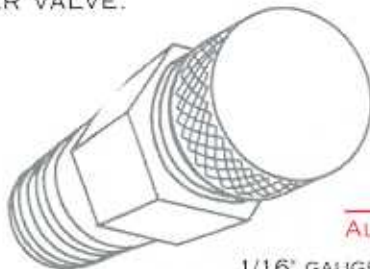

ALSO AVAILABLE

1/16" GAUGE ADAPTER FOR TRIDICATOR TO TAKE FULL RANGE PRESSURE AND TEMPERATURE READINGS.

## SISCO PLUGS ARE UNIQUE

UNIQUE IDEAS FOR USING A SISCO PLUG...

- INJECT OR EXTRACT SUBSTANCES FROM LINES WHILE IN OPERATION
- BLEED AIR OR GASES
- SEPARATE EXTENSION: YOU CAN USE THE SAME TEST EQUIPMENT ON PLUGS WITH EXTENSIONS... "OUR CORE IS ALWAYS AT THE TOP."
- MEASURE FLOW RATES:

POSITION ONE PLUG ON EACH SIDE TO BE TESTED. DETERMINE PRESSURE VARIANCE BY SUBTRACTING THE DOWNSTREAM READING FROM THE UPSTREAM READING. PRESSURE DIFFERENTIAL CAN BE USED TO DETERMINE FLOW RATE.

## TEST PLUG WITH PLASTIC CAP RETAINER AND EXTENSION

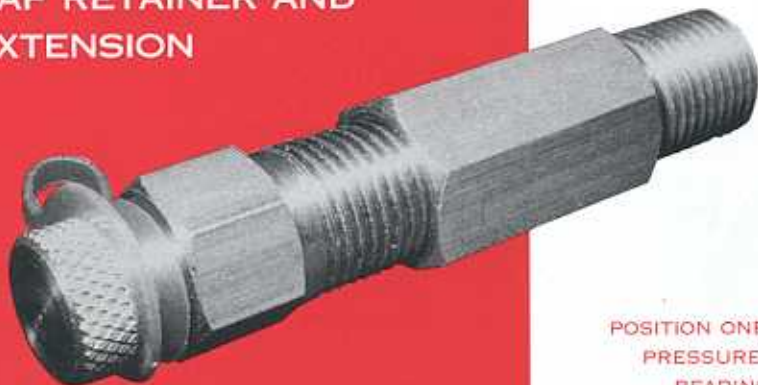

# RECOMMENDED LOCATIONS FOR P/T TEST PLUGS FOR BALANCED HEATING AND COOLING SYSTEMS

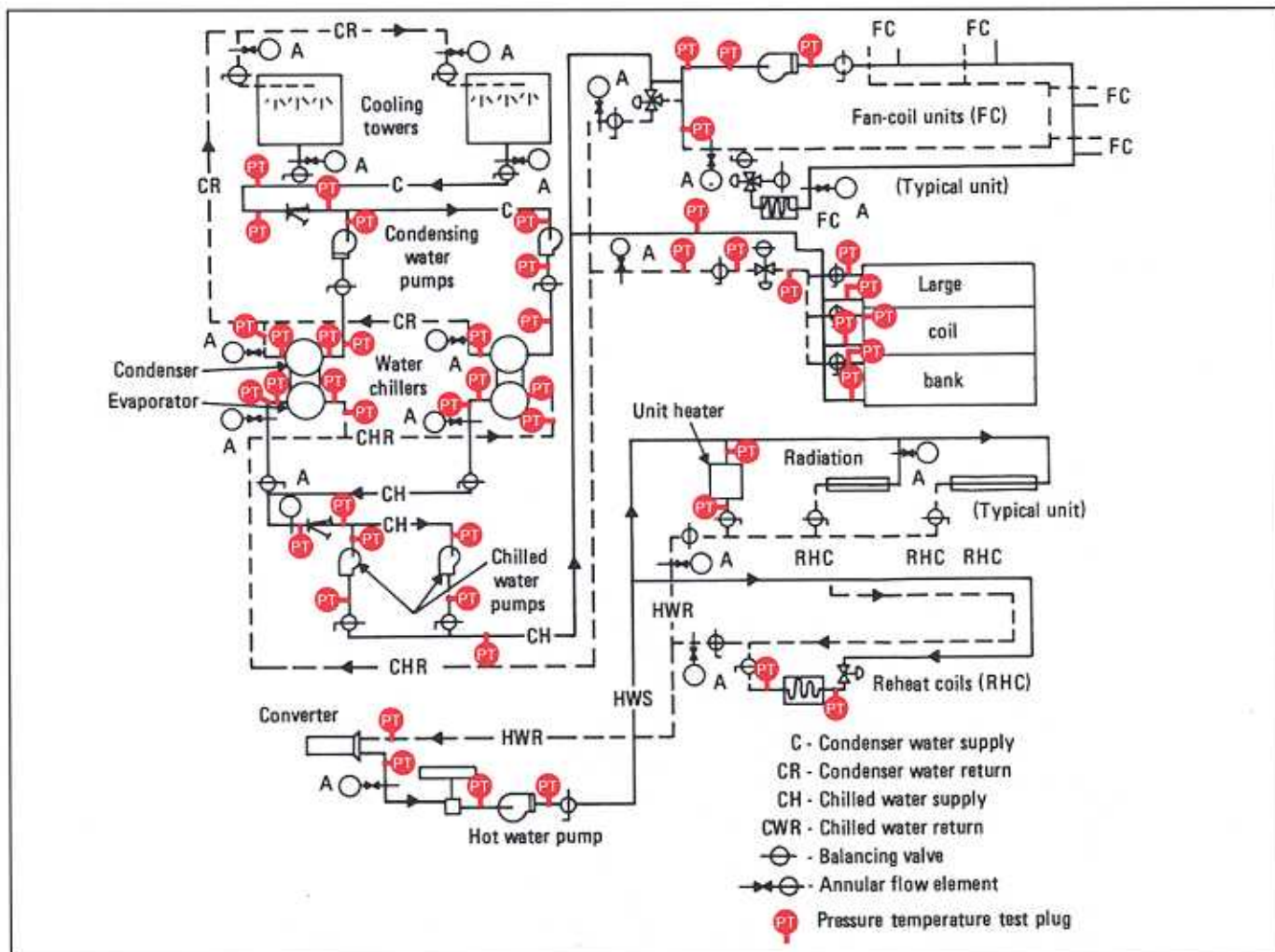

COMPLEX, PRESENT DAY SYSTEMS NECESSITATE ACCURATE PRESSURE/TEMPERATURE MEASUREMENTS FOR A QUICK, ECONOMICAL METHOD TO BALANCE HEATING AND AIR CONDITIONING SYSTEMS. SISCO PLUGS ALLOW EASIER, MORE ACCURATE TESTING FOR LESS.

## SISCO PLUGS PASS THE TEST, SAVE TIME & MONEY

SISCO PLUGS PROVIDE ACCESS TO FLUIDS AND GASES IN CLOSED SYSTEMS WITHOUT DISRUPTION.

- MEASURING:  
PRESSURE/TEMPERATURE/FLOW RATE
- SAMPLING:  
RETRIEVE SAMPLES WITHOUT DISRUPTING SYSTEM
- BLEEDING:  
BLEED AIR FROM A/C LINES TO INCREASE EFFICIENCY
- SINGLE SET OF GAUGES TO TEST OR SAMPLE ALL POINTS.

SAVE THE ADDED EXPENSE OF PERMANENT INSTALLATIONS AND MULTIPLE TEST EQUIPMENT.

- QUICKLY MOVE FROM POINT TO POINT  
FINGERTIP CAPS PROVIDE QUICK AND EASY ACCESS.
- SECURITY  
TESTING EQUIPMENT IS NOT DUPLICATED NOR PRONE TO VANDALISM, CLIMATE EXTREMES AND CORROSIVE CONTAMINANTS.
- FLEXIBILITY AND DURABILITY

# DESCRIPTIONS OF SISCO PLUGS AND ACCESSORIES

NUMBER	SIZE NPT	DESCRIPTIONS		MAX TEMP
		BODY/CAP MATERIAL	PLUG CORE	
BNO-125	1/8"	BRASS	NORDEL	350°
BNE-250	1/4"	BRASS	NEOPRENE	200°
BNO-250	1/4"	BRASS	NORDEL	350°
SSNE-250	1/4"	S/S	NEOPRENE	200°
SSNO-250	1/4"	S/S	NORDEL	350°
BNE-375	3/8"	BRASS	NEOPRENE	200°
BNO-375	3/8"	BRASS	NORDEL	350°
BNE-500	1/2"	BRASS	NEOPRENE	200°
BNO-500	1/2"	BRASS	NORDEL	350°
SSNE-500	1/2"	S/S	NEOPRENE	200°
SSNO-500	1/2"	S/S	NORDEL	350°

DEZINC BRASS AVAILABLE - CONSULT FACTORY

## ACCESSORIES AND GAUGE ADAPTERS

PC-250	1/4"	PLASTIC	CAP RETAINER
PC-375	3/8"	PLASTIC	CAP RETAINER
PC-500	1/2"	PLASTIC	CAP RETAINER
BTX-250	1/4" M/F	NPT BRASS	EXTENSION 1 3/4"
BTXX-250	1/4" M/F	NPT BRASS	EXTENSION 2 3/4"
BTXXX-250	1/4" M/F	NPT BRASS	EXTENSION 4 3/4"
BTX-500	1/2" M/F	NPT BRASS	EXTENSION 1 3/4"
GA-063	1/16"	S/S	PROBE
GA-125	1/8"	S/S	PROBE
GA-125S	1/8"	S/S	SHORT PROBE

## GAUGES

2 1/2" OR 3 1/2" DIAL FACE - 1/4" NPT MALE

MODEL		RANGE
2 1/2" DIA	3 1/2" DIA.	
G2-30	—	0-30 PSI
G2-60	—	0-60 PSI
G2-100	G3-100	0-100 PSI
G2-160	—	0-160 PSI
G2-200	—	0-200 PSI

## THERMOMETERS

1" OR 2" DIAL FACE - 5" STEM WITH EXTERNAL CALIBRATION

MODEL		RANGE
1" DIA	2" DIA	
T-125	—	25° TO 125° F
T-160	TX-160	-40° TO 160° F
T-220	TX-220	0° TO 220° F
T-500	—	50° TO 500° F

THERMOCOUPLE THERMOMETER WITH DIGITAL READOUT -50 TO 1000° F AND RIGID PROBE - .063" THIS SPECIAL THERMOMETER CAN MEASURE TEMPERATURE IN 1/8" TEST PLUG.

## TEST KITS

MODEL	CASE	2 1/2" GAUGE	3 1/2" GAUGE	GA	THERMOMETERS
TK 1-2-5	1	1	—	1	2
TK 2-2-5	1	2	—	2	2
TK 1-3-5	1	—	1	1	2
TK 2-3-5	1	—	2	2	2

(1) T-220 AND (1) T-500 SUPPLIED STANDARD UNLESS OTHER RANGES REQUESTED

# ENGINEERING SPECIFICATIONS FOR HYDRONIC APPLICATIONS

## A. INSTALL A SISCO 1/4" (1/8", 3/8", 1/2" NPT OR BSP)

TEST PLUG OF SOLID BRASS (STAINLESS STEEL OR DEZINC BRASS) INTO APPROPRIATELY SIZED WELDED SOCKET, THREADED BOSS, VALVE OR VESSEL. PLUGS SHALL BE LOCATED PER PROJECT DRAWINGS. TEST PLUG SHALL HAVE A DUAL SEAL CORE OF NORDEL, GOOD UP TO 350° F FOR WATER, (OR NEOPRENE TO 200° F FOR NATURAL GAS\*) AND SHALL BE RATED ZERO LEAKAGE FROM VACUUM TO 1000 PSIG. PLUG SHALL BE CAPABLE OF RECEIVING A PRESSURE OR TEMPERATURE PROBE.

## FOR 1/4" (3/8" OR 1/2" NPT OR BSP) TEST PLUG ONLY

B.1 OWNER SHALL BE PROVIDED WITH ONE (1) MASTER TEST KIT. KIT SHALL CONTAIN ONE OR TWO 2 1/2" OR 3 1/2"

PRESSURE GAUGES OF SUITABLE RANGE, ONE OR TWO GAUGE ADAPTER(S) 1/8" O.D. PROBE(S) AND TWO 5" STEM POCKET TESTING THERMOMETERS CONSISTING OF ONE 0-220° F, AND ONE 50-550° F IN A STURDY CUSTOM CARRYING CASE.

## FOR 1/8" NPT (OR BSP) TEST PLUG ONLY

B.2 OWNER SHOULD BE PROVIDED WITH MASTER TEST KIT. KIT SHALL CONTAIN ONE OR TWO 2 1/2" OR 3 1/2" PRESSURE GAUGE(S) OF SUITABLE RANGE, ONE OR TWO GAUGE ADAPTER(S) GA-063 THAT HAVE 1/16" O.D. AND A STURDY CARRYING CASE. TEMPERATURE READINGS ARE NOT APPLICABLE WITH THIS KIT. IF YOU NEED TO TAKE TEMPERATURE READINGS WITH THESE PLUGS, PLEASE CALL THE FACTORY!

\*FOR APPLICATIONS OTHER THAN WATER, CONSULT THE FACTORY

THERMOMETER

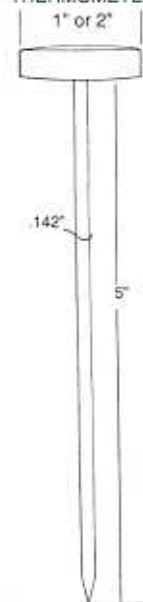

2 1/2" OR 3 1/2" DIAL FACE  
PRESSURE GAUGE

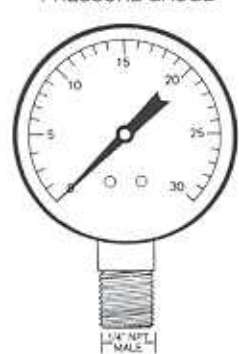

PLASTIC CAP RETAINER  
FOR KNURLED CAP (Optional)

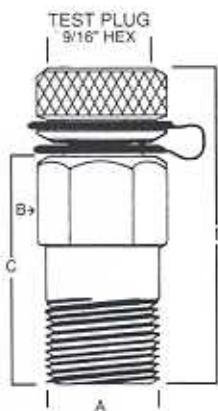
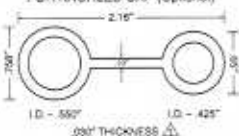

A	B	C	D
1/8" NPT	9/16" HEX	13/16"	1 1/4"
1/4" NPT	9/16" HEX	1 1/16"	1 1/2"
3/8" NPT	5/8" HEX	1 1/16"	1 1/2"
1/2" NPT	7/8" HEX	1 1/16"	1 1/2"

GAUGE ADAPTOR  
1/4" NPT Female

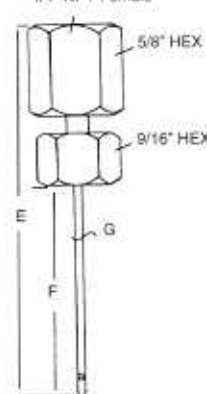

MODEL	E	F	G
GA-063	2 3/4"	1 3/4"	.063"
GA-125	2 3/4"	1 3/4"	.125"
GA-125S	2 1/4"	1 1/4"	.125"

NPT EXTENSION BRASS

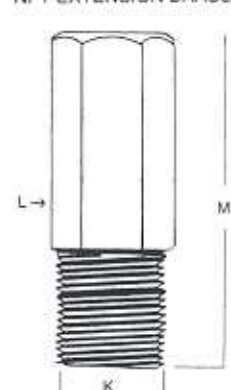

MODEL	K	L	M
BTX-250	1/4" NPT	9/16" HEX	1 3/4"
BTXX-250	1/4" NPT	9/16" HEX	2 3/4"
BTXXX-250	1/4" NPT	9/16" HEX	4 3/4"
BTX-500	1/2" NPT	7/8" HEX	1 3/4"

## SISCO TEST KITS DESIGNED TO SUPPORT OUR PLUGS

CONFORMING TO THE SPECIFICATION REQUIREMENTS OF CONSULTING ENGINEERS AND TO PROVIDE THE CUSTOMER WITH A MASTER TEST KIT.

SISCO PRESENTS FOUR TEST KITS IN A STURDY CUSTOM CARRYING CASE. REMEMBER, ONE PORTABLE IS BETTER THAN MULTIPLE PERMANENT INSTALLATIONS.

### INSTALLATION INSTRUCTIONS

1. PIPE SHOULD BE PREPARED TO ACCEPT TEST PLUG BY HAVING THE PROPER SIZE "T" OR SOCKET INSTALLED ON THE PIPE.
2. CAUTION: BE SURE THE TEST PLUG IS INSTALLED ON THE TOP HALF OF THE PIPE. NEVER INSTALL TEST PLUGS ON THE BOTTOM SIDE OF A PIPE!
3. PREPARE TEST PLUG FOR INSTALLATION BY SEALING NPT OR BSP THREADS WITH TEFLON TAPE.
4. WARNING: OPERATOR SHOULD ALWAYS WEAR PROTECTIVE CLOTHING AND SAFETY GOGGLES WHEN USING TEST PLUG.
5. SCREW TEST PLUG INTO SOCKET UNTIL IT IS FIRMLY SEALED INTO THE SOCKET.
6. PLACE SYSTEM UNDER OPERATING CONDITIONS.

### OPERATION INSTRUCTIONS

1. SCREW GAUGE ADAPTER ON PRESSURE GAUGE (IF TESTING PRESSURE). BE SURE TO ENGAGE SWIVEL NUT ON GAUGE ADAPTER FOR SAFETY PURPOSES.
2. PREPARE GAUGE ADAPTER OR THERMOMETER STEM FOR INSERTION INTO TEST PLUG BY CLEANING IT. EXAMINE IT FOR BURRS AND APPLY A SMALL AMOUNT OF SILICONE LUBRICANT.
3. CARE SHOULD BE TAKEN TO SELECT THE PROPER GAUGE RANGE. IF YOU GUESS WRONG THE PRESSURE GAUGE COULD EXPLODE IN YOUR HAND.
4. SLOWLY REMOVE PROTECTIVE CAP. IF YOU BEGIN TO SEE OR HEAR ANY LIQUID OR GASES ESCAPING, RETIGHTEN CAP IMMEDIATELY AND DETERMINE PROBLEM. REPLACE TEST PLUG IF NECESSARY.
5. IT IS RECOMMENDED TO CARRY SPARE CAPS OR PURCHASE THE OPTIONAL CAP RETAINER.
6. INSERT THE PRESSURE GAUGE WITH GAUGE ADAPTER (OR THERMOMETER) INTO THE TOP OF THE PLUG.
7. DO NOT LEAVE PROBE IN THE PLUG ANY LONGER THAN REQUIRED.
8. REMOVE MEASURING DEVICE AND SECURE CAP QUICKLY. **NOTE:** IN TEMPERATURES BELOW 45° F, PLUG MAY CLOSE SLOWLY.
9. CAPS SHOULD ALWAYS BE INSTALLED WHEN TEST PLUG IS NOT IN USE.

